

Experimental Investigation on the Port Timing of a Compressed Air Engine with Exhaust Predicting Technique

Nikhilkumar Chotai*‡, Vivek Patel**, Vimal Savsani***

*Department of mechanical engineering, Marwadi University, Rajkot Gujarat India

**Department of mechanical engineering, Pandit Deendayal Petroleum University, Gandhinagar, Gujarat, India

***Department of engineering, Canadore Collage, ANorth bay, ON, Postal, Canada

(nikhil.chotai@marwadieducation.edu.in, viveksaparia@gmail.com, vimal.savsani@gmail.com)

‡ Corresponding Author: Tel: +91 9825755795, nikhil.chotai@marwadieducation.edu.in

Received: 06.09.2020 Accepted:12.10.2020

Abstract - The air engine is one of promising propulsion system in the era of crisis of fossil fuels and demand for efficient, low emission technology. Friction due to conventional cam mechanism created a scope of research to improve the performance of the engine. Camless engine replaces the convention cam by variable valve train mechanism. Variable valve train comprises the electronics solenoid operated direction control valve and have the capability to rising cylinder pressure quick. In the air engine, compressed air entered into the cylinder requires enough time for expansion and the amount of air remains to expand reflects a higher exhaust pressure. Along with this, how quickly released expanded air and their relationship with performance is critical aspects of analysis. In this research, work-study concentrated on intake advance angle (ISA) and exhaust advance angle (EAA) which directly reflects on the amount of air entered and time required for complete expansion. Experiments conducted with the electronics control unit (ECU), predicts exhaust pressure based on expansion takes place in the cylinder. Results evidence of improvement in the performance of the engine with ISA with the controller only. Consequently, the experimental study provides a base for the design and development of self-decisive pollution-free engine system for improved performance.

Keywords: air engine, controlled engine, camless, ISA & EAA, variable valve train, valve timing, work efficiency.

1. Introduction

The new source of energy and environmental crises leads to the development of new technology in the field of vehicle propulsion. Generation of pollutant particles with the use of fossil fuels in the internal combustion engine (ICE) has a significant role in the current environmental issue [1]. Solar, wind and compressed air energy are the renewable source of energy and have an open platform to resolve the environmental issues. Düz et al. has developed the mathematical relationship for efficient utilization of solar a prime source of the renewable source to produce compressed air [2]. Furthermore, Priyadharsini et al. have experimentally validated that solar to compressed air energy conversation has 53.7 % work efficiency [3]. Thus, the compressed air engine

has a rich opportunity to emerge as a renewable propulsion technology. Motor Development International (MDI) and TATA have developed a set of novel air-powered engine and vehicle in the last few years. In China Zhejiang University also succeeded in the development of compressed air car [4]. These works demonstrate that compressed air can be used as a source of energy to drive vehicle and also the feasibility aspect of on-road is almost on the edge of the end solution.

Air engine study is now narrow down from basic system design to efficient subsystem design. 29 % of total power losses is merely due to friction in the conventional cam mechanism in the diesel engine at 5000 revolution per minute

(RPM) [5]. Friction in cam and follower mechanism raised the attentiveness and disentangle the problem of losses by the introduction of the variable valve (electronic operated solenoid direction control valve). Extremely fast direction control valve (DCV) has capabilities to reduce the 16 % friction losses in the engine [6]. Even DCV easily controlled by the controller and have acceptance of instant change in timing of the inlet valve and exhaust valve. Gould et al. experimented with electronics solenoid valve for pneumatic actuators to produce a nearly square wave valve lift profile and result were in favour [7]. Thus, the introduction of DCV in the air engine proven the track record to lead toward the improvement in the performance of the air engine.

Although the application of air engine and involvement of variable valve control has created great interest among research scholar, previous studies have concentrated on engine modelling and simulation. Few studies have focused on the key factor i.e. valve timing at convenient to inlet pressure. Wang et al. Worked on a prototype model of motorcycle and experiments are carried out on the effect of variation in intake timing and found it helpful in the form of vehicle travel distance but with compromise in torque [8]. Chen et al. simulation on port timing conclude that concluded each valve timing has a range of values that can opt to have better performance of the engine [9]. Qihui et al. presented a mathematical model on the dimensionless methods and explored the effect of intake and exhaust duration angle but neglecting energy efficiency. [10]. Kumar et al. work out on an optimum advance injection angle and found that maximum power obtained at 10^0 advance crank angle (CA) [11].

Above reviews determine the significance of air engine feasibility, employment of DCV and valve timing, though the research in the field of efficient overall control system requires attention. Based on these aspects, the core part of the current work is the development of an electronics control unit which satisfy optimize valve timing automation for overall performance improvement. Experiments are carried out for a pressure range, to find the effect of inlet pressure on the ISA and EAA.

Eventually, the results obtained provide the base for the feasibility study of new kind of propulsion technology and real-life implementation of low emission-controlled air engine in the vehicle system. Even utilization of air engine can extend for hazardous work atmosphere and as an expander in CAES (Compressed Air Engine System)[12], [13].

2. The Methodology and Experimental Setup of Controlled Camless Air Engine

In this experimental study, a reciprocating type engine modified from ICE was used. Conventional cam mechanism drives through the chain drive was removed and now inlet and exhaust valve can work independently. High pressurised air enters into the cylinder and pushes the piston downward and connecting rod and crankshaft converts into rotary motion. Considering the on-road application of the vehicle, there is a requirement of variable acceleration and

torque, which can be controlled by varying inlet pressure and valve timing.

The engine comprises two-phase intake and exhaust phase as presented in figure 1. There are three main crank angles are associated with the two phases. The first phase of the air engine cycle is a combination of air intake and expansion and controls the time duration of inflow of compressed air i.e ISA (Intake sustain angle). EAA (Exhaust advance angle) associated with the first phase and regulates early exhaust of expanded air. Second phase is mainly covers the exhaling of air. IAA in second phase regulates advance opening of intake angle, which is not accounted in this work. Amount of air entered into the cylinder depends upon the intake duration i.e ISA. If there will be higher the duration of intake, more amount of compressed air enters into the cylinder. Compressed air entered into the cylinder requires sufficient time to have complete expansion. Thus ultimately air entered into the cylinder, rate of expansion and the amount of air remains to expand reflects in the form of higher exhaust pressure. Considering this a control system build-up which calculates the instantaneous cylinder pressure and volume and predicts the exhaust pressure. Once the predicted exhaust pressure reaches to atmospheric pressure controller passes the signal to the inlet valve and closes DCV. Thus the controlled exhaust predictive system controls the ISA. As EAA controls, how quick the expanded waste air exhaust from the cylinder and thus, EAA was also accounted in the experiments to analyze the effects on the performance of the engine. Along with this experimentally also analysed the effect of input pressure on ISA and EAA and the ultimate effect on the performance of the engine.

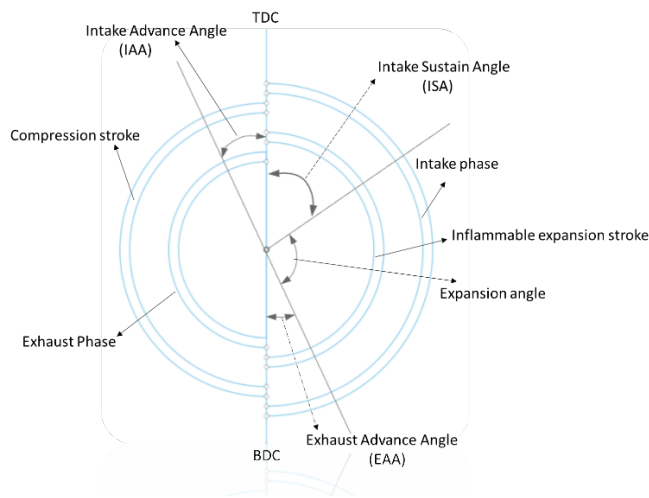

Figure 1 Detailed phase of the engine cycle

3. Experimental setup and procedure of the air engine

The experimental workbench prepared at Marwadi University research lab as shown in Figure 2 Experiment was carried out on 100 cubic centimetres four-stroke engine and the specification of the engine is described in table 1. DCV was used to on and off the supply into the cylinder. DCV

controls by the dedicated control system and operates to open and close the inlet and exhaust valve. 3 port and 2 position - 3/2 high frequency (3.5

Millisecond port switching time) DCV was used to reduce air movement and to reduce switching time of the valve. In DCV the only spool is the moving parts and reduces the friction losses. The pneumatic circuit has presented in figure 3 shows the port connection arrangement and air path. Open source microcontroller used to build up an electronic control unit (ECU). Controller working programme explained through the flow diagram in figure 4. As the per-flow diagram of ECU, initially, the controller passes the electronic signal to keep both valves in close condition. First crank angle was setup manually such that the piston position is exactly at the top of the cylinder. Once the cycle starts, the intake DCV port changes the position and allows compressed air to enter the cylinder. Due to the simultaneous expansion crank rotates and that rotation measured by Autonics made 1024 PPR (Pulse per revolution) rotary encoder having accuracy to measure up to least 0.3° . Along with this cylinder pressure measured using Janatics made digital pressure sensor having a response time of $< \pm 2.5$ milliseconds. A controller receives the feedback of pressure and crank angle and based on that controller calculates the predictive exhaust pressure (P_{ex}) and once it reaches near to atmospheric pressure, passes the signal to close the inlet valve. In the next decision step of controller crank angle compared to EAA (S_{L1}) set angle and once it reaches to limit exhaust valve opens and the next exhaust phase starts. EAA varied in the experiments from 180° CA to 160° CA. In the exhaust phase, once the crank reaches to 360° CA, cycles complete. Here in all decision stages of comparison of crank angle tolerances are provided to compensate limitation of sensors and controller in the form of δ_1 & δ_2 and set value of that tolerance is 6° . For exhaust pressure tolerance value set with the symbol of K and that was in the percentage of atmospheric pressure (P_0) i.e $K = 1.2$ means P_{ex} reaches 20% higher than the atmospheric pressure, passes the signal to open exhaust valve. To evaluate the effect of variation of ISA and EAS concerning inlet pressure, 3.0 to 5.5 bar pressure range was chosen the experiments.

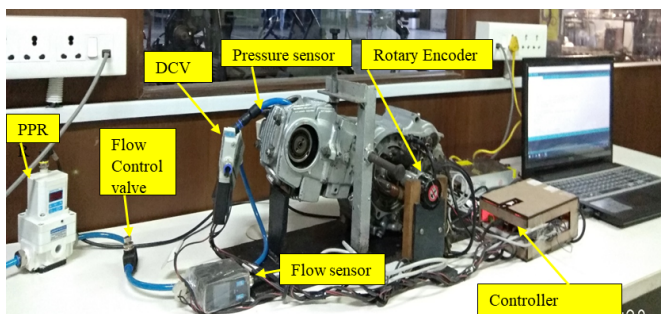

Figure 2 Experimental set-up of camless air engine

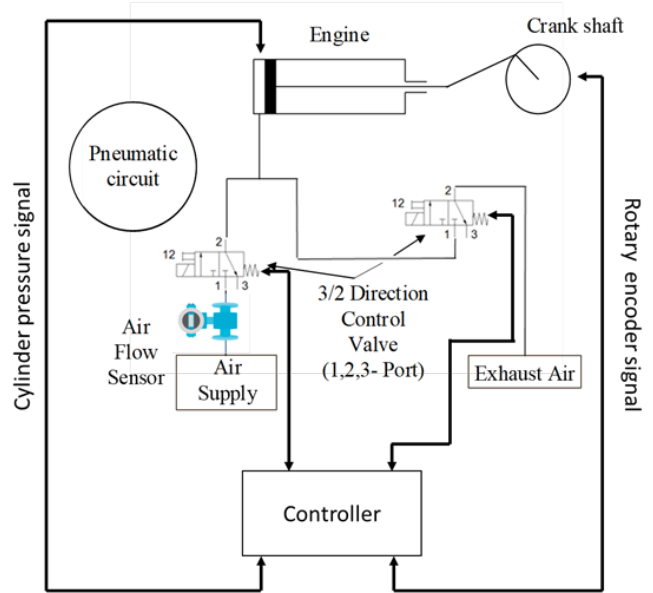

Figure 3 Schematic diagram of the engine, controller and pneumatic circuit

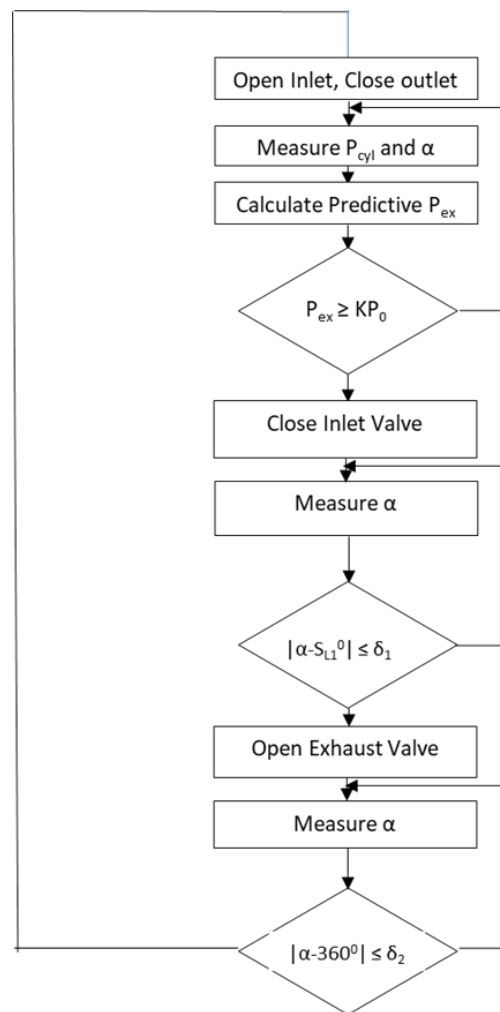

Figure 4 Controller flow diagram

Where,

| | |
|-------------------------|---|
| P_{cyl} | Cylinder mean pressure (Bar) |
| α | Crank angle |
| P_{ex} | Exhaust pressure (Bar) |
| P_0 | Atmospheric pressure (Bar) |
| S_{L1} | Tolerance limit of the EAA |
| δ_1 & δ_2 | factor, compensate for the range of crank angle (tolerance value) |

Table 1 Specification of engine

| Engine Parameters | Value |
|-------------------------------|-------|
| Length of connecting rod (mm) | 94 |
| Bore diameter (mm) | 49 |
| No. of Cylinder | 1 |
| Crank radius (mm) | 26 |

4. Mathematical Model of Air Engine

Air engine parameters i.e. instantaneous cylinder pressure, volume and temperature are used to build the mathematical relationship to evaluate the performance of the engine. Mathematical model details each input and output parameters of the air engine. Air engine operational cycle considered as a thermodynamic cycle with the following assumption for simplifications.

1. The compressed air is considered as an ideal gas.
2. Specific heat and specific enthalpy are the only functions of temperature.
3. The changes in kinetic and gravitational energy are considered as negligible.
4. There are no leakages in the air engine operation.
5. The injection and expansion of air in the cylinder is a polytropic process.
6. The friction or heat losses are negligible.

Air engine operation energy balance equation is as follows:

$$\frac{dU}{d\alpha} = \frac{dQ_{cb}}{d\alpha} + h_i \frac{dm_i}{d\alpha} + h_{ica} \frac{dm_{ica}}{d\alpha} + h_{ex} \frac{dm_{ex}}{d\alpha} + \frac{dW}{d\alpha} \quad (1)$$

Where,

| | |
|-----------|---|
| Q_{cb} | Heat absorbed by the air from the cylinder wall |
| h_i | Specific enthalpies of inlet air (J/Kg) |
| h_{ica} | Specific enthalpies of air in the cylinder (J/Kg) |
| h_{ex} | Specific enthalpies of exhaust air (J/Kg) |

| | |
|-----------|---|
| m_i | Mass of inlet air (Kg) |
| m_{ica} | Mass of air injection compressed air (Kg) |
| m_{ex} | Mass of exhaust air (Kg) |
| W | Mechanical work on the piston |

Where U is the internal energy of the air in the engine cylinder. Engine RPM is high, and the body of the engine is made of metal, the temperature of the internal wall is considered constant. Solenoid power consumption is not accounted for the energy balance because power consumption is constant in both the cases and considerably low i.e. 3 % of total power.

U can be written in the form

$$dU = d(m.u) = udm + mdu \quad (2)$$

Where,

u Specific heat

For air in control volume and no state component changes in the process, thus specific heat, u can be seen as a function of air temperature, and u can be written in differential form

$$\frac{du}{d\alpha} = \frac{\partial u}{\partial \theta} \frac{d\theta}{d\alpha} = C_v \frac{d\theta}{d\alpha} \quad (3)$$

Where,

| | |
|----------|------------------------------------|
| C_v | Constant volume-specific heat |
| θ | Temperature of air in the cylinder |

The output mechanical work by the compressed air is described by

$$\frac{dW}{d\alpha} = p_{inst} \frac{dv_{inst}}{d\alpha} \quad (4)$$

Where,

| | |
|------------|---------------------------------|
| p_{inst} | Cylinder instantaneous pressure |
| V_{inst} | Cylinder instantaneous volume |

Where, V_{inst} is the instantaneous cylinder volume and can be calculated using the structural equation of slider-crank and instantaneous piston position as

$$v_{inst} = \frac{\pi}{4} d^2 r \left[\frac{L}{r} + 1 - \cos\alpha - \left(\frac{L^2}{r^2} - \sin^2\alpha \right)^{\frac{1}{2}} \right] \quad (5)$$

Where,

| | |
|-----|--------------------------|
| r | Crank radius |
| d | Piston diameter (mm) |
| L | Length of connecting rod |

Expansion of compressed air in the cylinder is considered a polytropic process and with the above equation, exhaust pressure can be described as following [14]:

$$p_{ex} = p_{inst} \frac{\pi}{4} d^2 r \left[\frac{L}{r} + 1 - \cos\alpha - \left(\frac{L^2}{r^2} - \sin^2\alpha \right)^{\frac{1}{2}} \right]^n \quad (6)$$

Input power is the function of compressed air flow rate and pressure difference at inlet and cylinder pressure and can be expressed as [15]:

$$\frac{P_{in}}{d\alpha} = \frac{dQ}{d\alpha} * \frac{d\Delta P}{d\alpha} \quad (7)$$

Where,

- ΔP The pressure difference of at supply end of tank and cylinder mean pressure
- P_{in} Input power
- Q Compressed air volumetric flow rate (LPM)

By integration for the whole cycle can calculate the input flow power and output mechanical work done and efficiency can be expressed as:

$$\eta = \frac{W}{Q * \Delta P} \quad (8)$$

Where,

- η Work efficiency

5. Result and Discussion

In this work, experiments were conducted to analyze the effects of ISA and EAA with controlled predictive cycle. Experiments were carried out with pressure from 3.0 to 5.5 bar inlet pressure to find the effect of pressure on valve timing i.e. ISA and EAA. Along with predictive controlled cycle constraints of variation in EAA was added in the controller and results obtained accordingly. EAA range for all pressure was chosen from 180° to 160° CA.

In the air engine whatever the compressed air remains to expands reflect in terms of higher the exhaust pressure. Predictive exhaust pressure control system controls the intake duration (ISA) of air by predicting instantaneous exhaust pressure. EAA covers the exhaling of waste expanded air of the cylinder. Early opening of exhaust valve quickly release the these expanded air but there is no relation with efficiency and other performance parameters of the engine and due to this there will no more comparative effect of variation of EAA. Subsequent experimental results present the effect of EAA variation on the performance of the engine.

Figure 5 represents the variation in efficiency with the change in EAA and can see that efficiency decreasing with an increase in inlet pressure but there is no more effect of change in EAA. There was an average 5.0 % percentage efficiency deviation recorded with change in EAA. Efficiency is inversely proportional to the pressure difference. Pressure difference at different inlet pressure presented with figure 6. The figure indicates that with increasing inlet pressure there will be great pressure difference because air moves from pipe to higher area of the cylinder and comparatively expands more.

Direction control valve produces the square curve of cylinder pressure and increases cylinder pressure quickly. Work done is the function of instantaneous cylinder pressure and volume. Controlled predictive cycle controls the intake sustain angle and directly affects the work done. Change in

work done with variation in EAA logged only 4.7 %, as shown in figure 7.

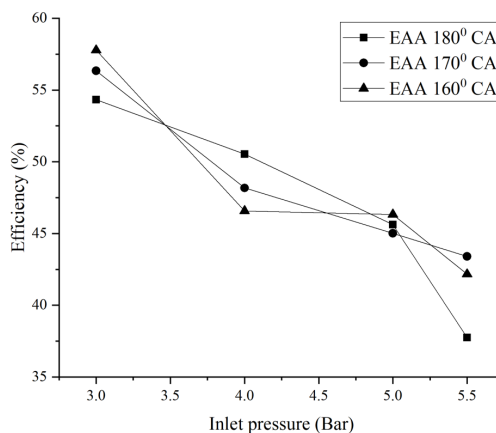

Figure 5 Efficiency variation at different EAA

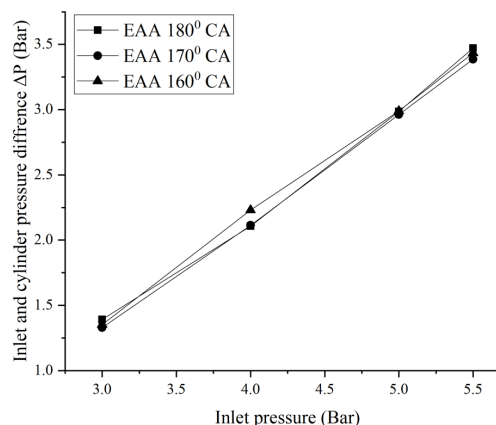

Figure 6 Inlet and cylinder pressure difference at the different inlet pressure

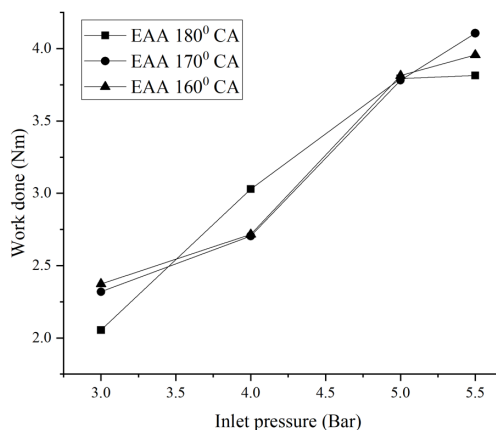

Figure 7 Work done at different EAA

Figure 8 shows the engine shaft RPM variation with controlled predictive cycle and change in EAA. Increasing the inlet pressure increase the RPM of the engine as the compressed air move rapidly because of the pressure difference at inlet pipe and cylinder and thus increase the RPM of the engine. EAA does not affect the RPM of the engine. The average deviation in the RPM is 2.5 % and the maximum deviation in RPM is at 3 bar inlet pressure and it was 4.0 % with change in EAA.

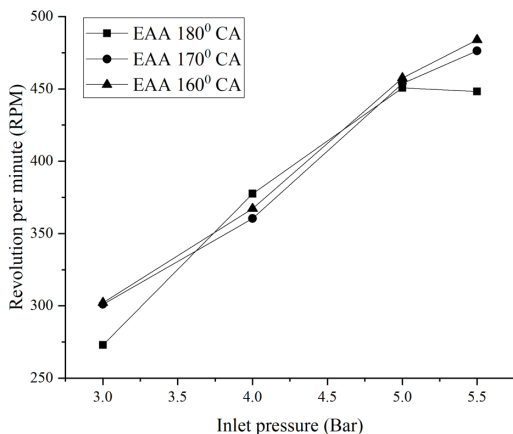

Figure 6 RPM of the engine in a controlled predictive cycle with variation in EAA

Flow rate maintained almost constant at each pressure to derive comparative results as shown in figure 9. Flow rate increases with increase in pressure. Average 3.5 % variation was recorded in the flow rate considering pressure range and EAA.

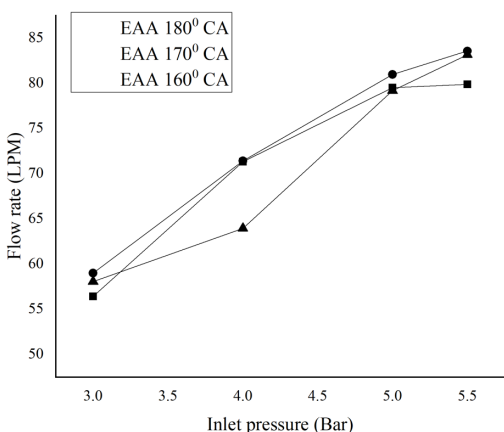

Figure 7 Compressed air flow rate condition at each inlet pressure

Figure 10 shows how the results of the exhaust predictive cycle at fixed EAA of 180° CA. Results show that at higher pressure, intake duration (ISA) be the lower to have more. At higher pressure more amount of compressed air enters into the cylinder and to have a complete expansion of

compressed air, ISA is low. Results show that with increasing pressure from 3 to 5.5 bar, ISA reduced from 145° CA to 119° CA.

As with increasing inlet pressure more the amount air enters into the cylinder, which can not be expands completely and result as high exhaust pressure compared to atmospheric pressure. Thus with predictive exhaust method controller decreases ISA with increasing input pressure and improve the efficiency of the cycle and utilize maximum input power. EAA directly related to exhaust pressure release process so it doesn't affect with the input pressure.

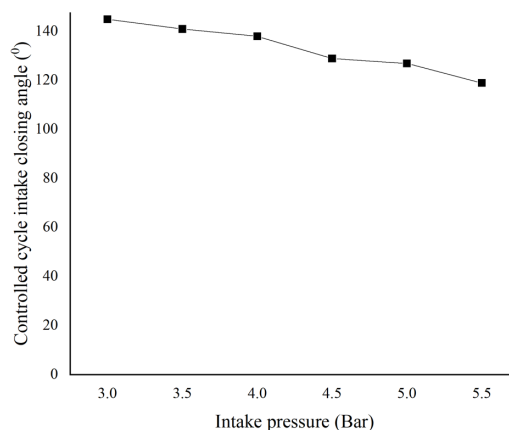

Figure 8 ISA control by exhaust predictive control cycle

6. Conclusion

In this research work, controlled predictive exhaust pressure cycle based camless air engine's performance was experimentally analysed for different EAA. Two prime valve timings covered in the study, EAA and ISA. The research results presented concludes the following points.

1. ISA directly reflects in terms of improvement of the performance of air engine.
2. Experimental study shows EAA does not affect more to the performance of the engine. There is only 4.0 % change in performance parameters of the engine, i.e. work efficiency, RPM and work done at an almost constant flow rate.
3. Exhaust predictive control cycle controls the intake duration by continuous prediction of exhaust pressure and chooses the optimum ISA so that entered compressed expands completely and improves the performance of the engine. Thus, after expansion, the exhaust pressure reaches atmospheric pressure, and work done, and work efficiency is improved.
4. The predictive control system can further analyse with exhaust delay angle and can optimize the controlling parameters using the controller.

ECU works on exhaust pressure predictive condition to control ISA. ISA plays vital role compared to ESA in the

improvement of efficiency, RPM and work done. Proposed experimental control system with ISA and ESA lays the foundation for the non-pollutant vehicle propulsion system.

References

- [1] B. R. Singh and O. Singh, "A study of performance output of a multivane air engine applying optimal injection and vane angles," *Int. J. Rotating Mach.*, vol. 2012, no. December 2013, 2012.
- [2] H. Düz, "Storing solar energy inside compressed air through a heat machine mechanism," *Gazi Univ. J. Sci.*, vol. 29, no. 2, pp. 245–251, 2016.
- [3] M. Priyadharsini, T. S. A. Narayanan, T. Singh, K. S. Sankaran, and P. M. Rubesh Anand, "Compressed air generator integrated with renewable energy source for military application," *Proc. 2019 IEEE Int. Conf. Commun. Signal Process. ICCSP 2019*, pp. 810–813, 2019.
- [4] L. Liu and X. Yu, "Practicality study on air-powered vehicle," *Front. Energy Power Eng. China*, vol. 2, no. 1, pp. 14–19, 2008.
- [5] C. Paper, A. R. Universit, U. M. View, and A. Ruggiero, "A four stroke engine friction model," no. September 2000, 2016.
- [6] S. Trajkovic, P. Tunestål, B. Johansson, U. Carlson, and A. Höglund, "Introductory Study of Variable Valve Actuation for Pneumatic Hybridization," vol. 2007, no. 724, 2018.
- [7] L. A. Gould, W. E. Richeson, and F. L. Erickson, "SA E TECHNICAL Performance Evaluation of a Camless Engine Using Valve Actuators with Programmable Timing," *Ind. Electron.*, 2011.
- [8] Y. W. Wang, J. J. You, C. K. Sung, and C. Y. Huang, "The applications of piston type compressed air engines on motor vehicles," *Procedia Eng.*, vol. 79, no. June, pp. 61–65, 2014.
- [9] Y. Chen, H. Liu, and G. Tao, "Simulation on the port timing of an air-powered engine," vol. 38, 2005.
- [10] Q. Yu, "Dimensionless Study on Efficiency and Speed Characteristics of a Compressed Air Engine," vol. 137, no. 10, 2016.
- [11] V. Kumar, J. Takkar, M. Chitransh, N. Kumar, U. Banka, and U. Gupta, "Development of an Advanced Compressed Air Engine Kit for Small Engine," *SAE Tech. Pap. Ser.*, vol. 1, 2014.
- [12] A. Ciocan, M. Tazerout, T. Prisecaru, and J. F. Durastanti, "Thermodynamic evaluation for a small scale compressed air energy storage system by integrating renewable energy sources," *2015 Int. Conf. Renew. Energy Res. Appl. ICRERA 2015*, pp. 455–460, 2015.
- [13] M. Moazzami, M. Ghanbari, J. Moradi, H. Shahinzadeh, and G. B. Gharehpetian, "Probabilistic SCUC considering implication of compressed air energy storage on redressing intermittent load and stochastic wind generation," *Int. J. Renew. Energy Res.*, vol. 8, no. 2, pp. 767–783, 2018.
- [14] N. J. Chotai, V. Savsani, and V. Patel, "Air Engine Efficiency Improvement Using Control System," in *Reliability and Risk Assessment in Engineering Proceedings of INCRS 2018*, J. N. Gupta V., Varde P., Kankar P., Ed. Springer, Singapore, 2020, pp. 381–388.
- [15] F. Zeng and J. Xu, "Theoretical and experimental research on the port timing of a compressed air engine," *Energy Sources, Part A Recover. Util. Environ. Eff.*, vol. 0, no. 0, pp. 1–14, 2019.