

An Improved PI-MultiStart Control Algorithm for Standalone PV Inverter System

Mushtaq Najeeb*[‡], Hatem Fahad*, Yasir Abdulhafedh*, K. G. Mohammed**, Ali Mahmood***

*Department of Electrical Engineering, College of Engineering, University of Anbar, Ramadi, Iraq

**Electrical Power and Machine Engineering Department, College of Engineering, Diyala University, Diyala, Iraq.

***Electricity Production Directorate of Salahaldeen, Ministry of Electricity, 34007 Baiji, Iraq

[‡]Corresponding Author; Mushtaq Najeeb, College of Engineering, University of Anbar, Ramadi, Iraq
eng.mushtaq2004@gmail.com

Received: 02.05.2017 Accepted: 16.07.2017

Abstract- This paper proposes an improved voltage controller using MultiStart optimization (MS) algorithm based PI (MS-PI) to control the modulation index for stand-alone PV inverter under different load conditions. In this proposed control algorithm (MS-PI), k_p and k_i parameters are automatically tuned to avoid the trial and error procedure in classical PI controller in order to minimize the output voltage error. To do so, the mean square error (MSE) is used as an objective function with the MultiStart algorithm code. MATLAB models (Simulink and Code) for a PV inverter and the proposed control algorithm are developed. In order to get the desired output voltage of the inverter, a statistical evaluation for the proposed controller (MS-PI) is investigated and compared with that one's obtained by particle swarm optimization (PSO) algorithm based PI approach (PSO-PI). Based on the results, the proposed controller has proven that its performance is robust and efficient in terms of total harmonic distortion (THD), regulated voltage amplitude in term of oscillation, and minimum value of mean square error (MSE) as compared to PSO-PI algorithm.

Keywords- PV standalone inverter, MultiStart optimization algorithm based PI (MS-PI), mean square error, total harmonic distortion.

1. Introduction

Photovoltaic system (PV) is one of the most significant topics in renewable energy resources (RES). The D.C electricity is generated from the sun light collection using PV modules and store it in such batteries [1, 2]. However, the DC-AC inverter is an important part in PV systems which convert the D.C voltage to A.C voltage. The voltage source inverter is applied with different sources of renewable energy such as photovoltaic solar, wind, fuel cell, and so on [3-9]. For standalone PV system, the inverter is located between the DC source and the loads to achieve the desired output [10, 11]. In addition, the output voltage and current waveforms for a voltage source inverter should be controlled based on a control technique by comparing their feedbacks with reference value. Thus, the main objective of a good inverter design regardless of different loads are externally connected [12-15] is the controller improvement to provide a constant frequency and amplitude voltage as mentioned in the international standard IEEE-519-1992 [16].

There are a lot of controllers' techniques have been applied in the literature to meet the successful effectiveness of the output inverter performance. For example, PI

controller used to regulate the voltage response for the PV grid system as in [17] because of its simplicity in structure design. The researcher in [18] has proposed a conventional controller of proportional-integral design to control the boost converter for the inverter system in order to get a good performance. In a related research, a field programmable gate array (FPGA) has been used in the PV inverter systems to develop the control algorithm described in [19, 20] but it considered a time consuming task because it needs a wide knowledge in software programming. In [21] a traditional PI controller has been proposed which requires differential equations to obtain a better performance by controlling the DC-AC inverter. On the other hand, it is difficult to tune the PI parameters (k_p, k_i) because of its mathematical model [22]. Therefore, the utilization of optimization techniques in tuning the PI controller has been widely investigated to improve the inverter performance. In [23], genetic algorithm (GA) has been utilized in finding the optimal PI parameters to control the inverter performance especially the output voltage. In addition, particle swarm optimization (PSO) has been applied in tuning the PI parameters for different types of applications [24–26]. Yet, a tuning method for finding PI

coefficients using MultiStart optimization algorithm (MS) has not been applied in the stand-alone inverter applications.

In this paper, an optimal PI controller using MultiStart optimization algorithm (MS) is proposed for the stand-alone inverter in order to get the desired output. In this control algorithm (MS-PI), the manual trial and error procedure in getting k_p and k_i parameters which used in classical PI controller is avoided under different load conditions. Based on this, the mean square error (MSE) is used as an objective function to evaluate the response performance and minimize the output voltage error for the inverter. Finally, the simulation results of the proposed controller (MS-PI) are compared with the obtained results by using (PSO-PI) controller. An explanation of other details is discussed in the following sections, section 2 describes the inverter model with proposed controller (MS-PI) using SVPWM. Section 3 explains the proposed optimal MS-PI controller and its flowchart including the MS algorithm concept. Finally, the results and discussion presented in section 4.

2. Inverter with Proposed Controller

The overall schematic diagram is shown in figure (1). It consists of a PV source, DC voltage, single-phase inverter (DC-AC), LC filter, an intelligent voltage controller connected through two different loads, and SVPWM method. The main feature of a good inverter is to generate the AC output voltage. The output voltage of the inverter (V_{Load}) can be sensed at the terminal of two different loads (R_1, R_2) and it can be represented as [27]:

$$V_{load} = V \sin \omega t \tag{1}$$

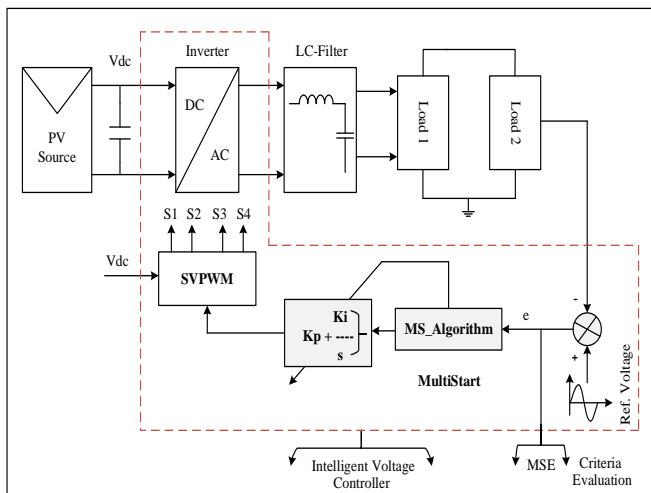

Fig. 1 Inverter model with proposed controller (MS-PI) using SVPWM

PI controller is one of the popular feedback controllers used with inverter applications for providing an excellent control performance and higher stability. The typical transfer function of the PI controller shown in equation (2) consists of two basic parameters; Proportional (P) and Integral (I) [28, 29].

$$G_{PI}(s) = \frac{U(s)}{E(s)} = K_p + \frac{K_i}{s} \tag{2}$$

Where, K_p is the proportional gain, K_i is the integration gain, $U(s)$ and $E(s)$ are the control signal and the error signal which computes the difference between the reference voltage (V_{ref}) and the measured output voltage (V_{Load}) correspondingly at each sampling time. After that, the generated error is then sent to the proposed controller which includes the harmony search algorithm based PI approach. Next, a comparison between $V_{control}$ and $V_{carrier}$ based bipolar SPWM method is done to derive the inverter by generating the IGBT switching signals in order to obtain the desired output. On the other hand, the designer must adjust the boundary values of the PI coefficients (k_p, k_i) in any standard design by using trial-and-error procedure until the result is satisfied [30, 31]. This is considered a time consuming task. Therefore, the optimization algorithms represent the optimal and the efficient solution to find the PI coefficients by considering the error (e) shown in equation (3) signal is the optimization problem.

$$e = V_{ref} - V_{Load} \tag{3}$$

3. Optimal (MS-PI) Controller

The optimal controller for the standalone inverter is shown in figure (1) which consists of MultiStart algorithm based PI approach (MS-PI). The MultiStrat (MS) is a well-known meta-heuristic optimization algorithm which considered a multiple decision criteria. It can be optimized simultaneously especially with the science fields including engineering to find either a set of optimal solutions [32, 33] or multiple local minima for bound constrained problems [33]. The output voltage error between the comparison of the reference voltage and the measured voltage is formulated as an optimization problem and the MS algorithm is able to search for the optimal controller parameters. In short, the optimization process starts by creating a new solution using a fitness function in order to improve the quality of the generated solutions.

A more explanation of the optimization process for controller parameters tuning using MS algorithm is presented in figure 2. The first step in this process is to initialize the solution boundaries of K_p, K_i which represent as start points and then it starts searching in local points of groups to find the global optima. The second step is to specify the properties of MS algorithm. Thirdly, local searches based on initial parameter 'x0' are started to generate start points. Next, run the overall system shown in figure (1) and find the fitness function value in order to search for the optimal values of the proposed control algorithm. The fourth step, update the start points and run the system again to find the new value of fitness function. After that, a comparison between the new generated fitness value and the previous

value is usually done to check the criteria of stopping conditions “which one has the minimum value”. If the new fitness value is smaller than the previous value, then the new value will be replaced by the old one. Else, the process will re-evaluate the fitness function shown in equation (4) through the run of local solver in next iteration. According to the run of local solver from multiple points, the best optimal value is chosen as the starting point in the current iteration and the generated optimal value is stored for next iteration. Finally, the optimal solutions of K_p, K_i are found and the objective function (MSE) for the MS optimization algorithm is computed as well.

For the investigation purpose, the proposed inverter parameters are shown in table 1. In addition, mean square error (MSE) is required as an objective function to evaluate the inverter performance [35].

$$MSE = \frac{1}{L} \sum_{p=1}^L (V_{ref} - V_{Load})^2 \tag{4}$$

Where L is the samples number which used to evaluate MSE , It can be defined as (simulation running time/sampling time).

Table 1: Proposed inverter parameters

Parameters	Values
Input DC voltage, V_{dc}	350 V
Filter inductance, L	4.7 mH
Filter capacitance, C	15 μF
Resistive load, $R1$	250, W
Resistive load, $R2$	500, W
frequency Switching, f_s	10 KHz

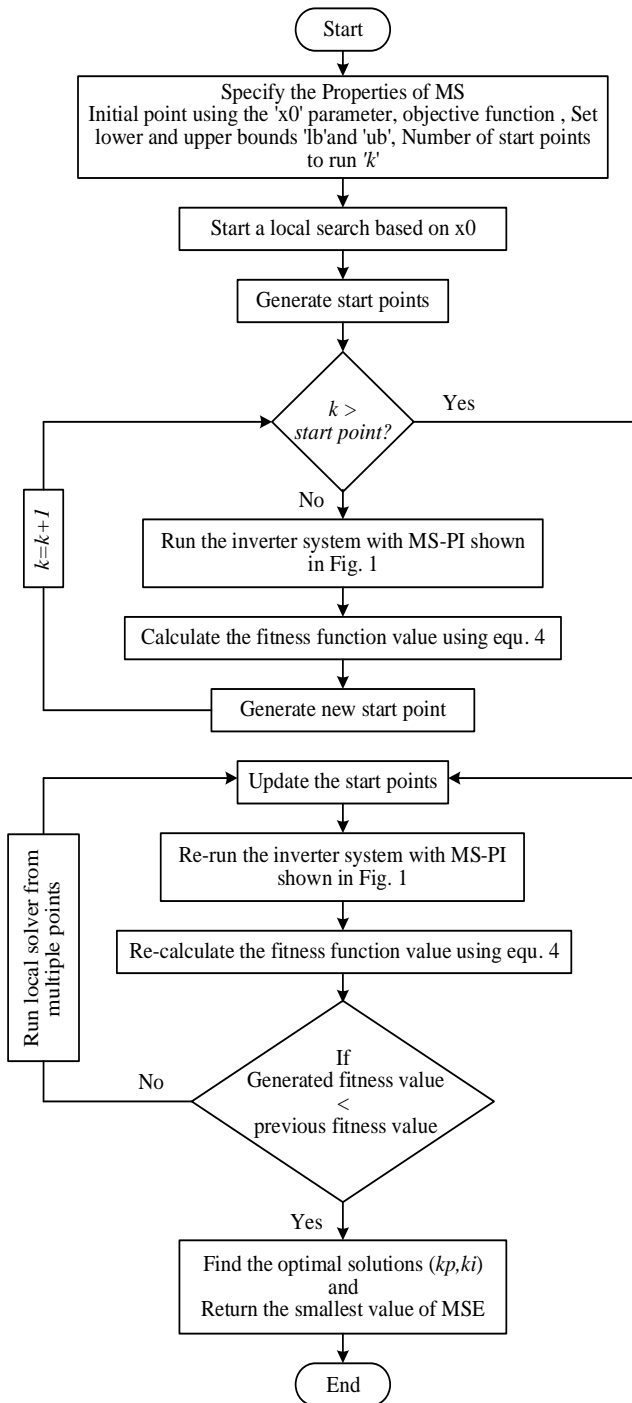

Fig. 2 Flowchart of MS optimization based PI

4. Results and Discussion

In this section, the proposed stand-alone inverter and the control algorithm shown in Fig. 2 were modeled and investigated using the environment of MATLAB Simulink/Code. There are two tests have been done to demonstrate the effectiveness of using the Multistart optimization algorithm based PI controller. The first one is statistical analysis, Fig. 3 displays the convergence characteristics of MS-PI as compared to the convergence characteristics obtained by using PSO algorithm based PI (PSO-PI). In both optimization algorithms, same parameters are used like number of iterations, population size, dimension of problem, and the objective function in equation (4). Based on Fig. 3, it is clear that the convergence of the proposed MS-PI is faster than PSO-PI. In other words, the obtained response of the overall inverter system is better and robustness under different loads conditions.

Furthermore, a Wilcoxon test was conducted to verify whether the obtained results by using MS-PI and PSO-PI algorithms are statistically significant. Based on the generated report, the ratio of the p-value for the HS-PI controller is less than 0.05 (p-value < 0.05). This is to indicate that the tested iterations which done by MS-PI is statistically better than PSO-PI. In addition, the box plot based on MS-PI and PSO-PI over 50 runs is described in Fig. 4 to demonstrate the effectiveness of the obtained solutions distribution by both algorithms. It is shown that the results of

solutions distribution which generated by MS-PI is better than PSO-PI especially the error value of the objective function (MSE) under different loads.

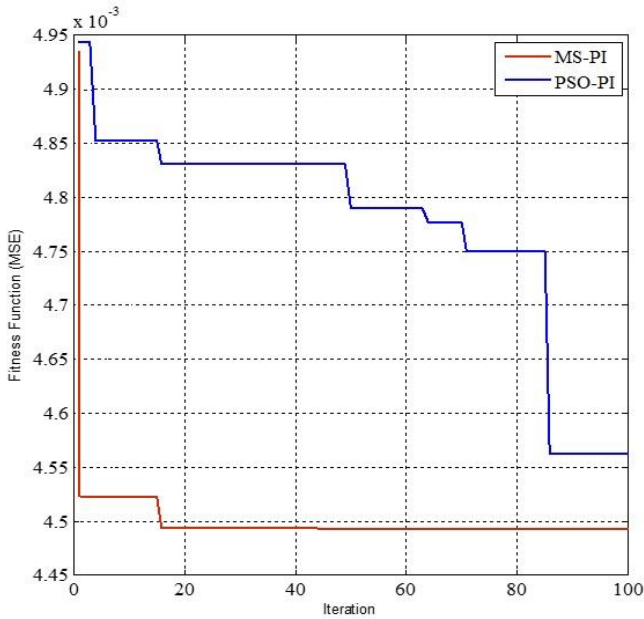

Fig. 3 Fitness function based on MS-PI and PSO-PI

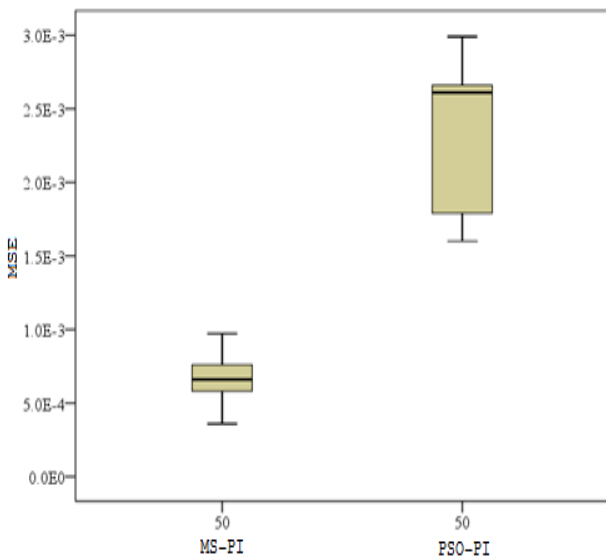

Fig. 4 Box plot based on MS-PI and PSO-PI

The second test, in this study, the simulation has been carried out for 0.2 s with resistive load is 250 W and the sampling time (T_s) is $1\mu s$ to assess the inverter performance. Figure 5 shows the waveform relationship between the current and the voltage for the proposed inverter, the rms voltage is 219.5V which equivalent to 310.5V as a peak voltage and the rms current is 2.5 A which equivalent to 3.55 A as a peak current. Both of them are sinusoidal with 50 Hz, where the load current is scaled up to show the phase difference with each other. It is observed that the phase shift is zero as expected (unity power factor).

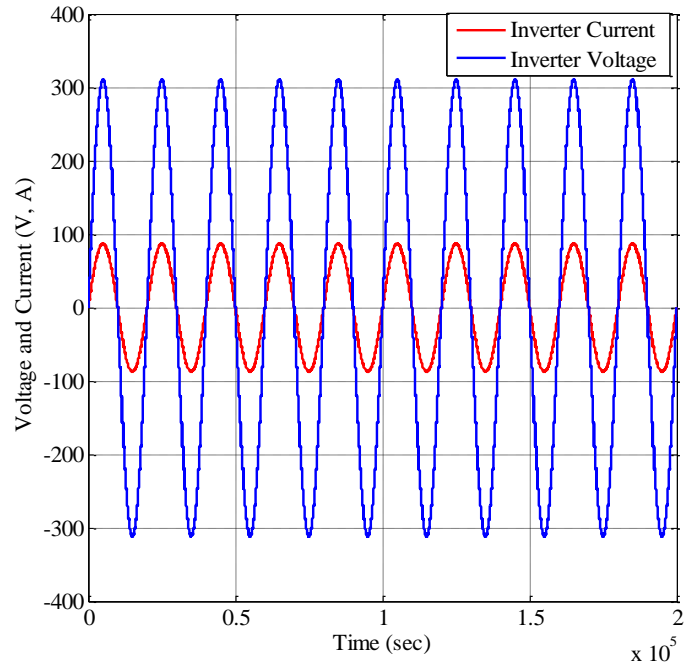

Fig. 5 Output voltage and current waveforms

To indicate the robustness of the proposed controller algorithm for the inverter, a sudden load change in the resistive load has been occurred. The load increased from 250 W to 500 W at 0.2 s, the total time for the simulation is 0.5 s. Fig. 6 shows the output voltage and current waveforms, it is noted that the stability of the sinusoidal waveform is clearly noted with 50 Hz through different load connected. Meanwhile, the response of transient and steady-state values is achieved quickly similar to the output voltage waveform.

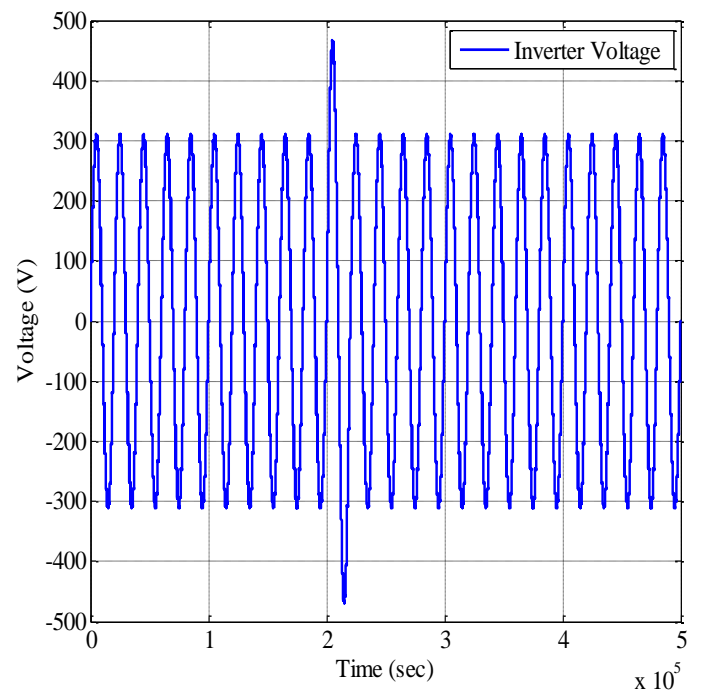

Fig. 6a Output Voltage during load change

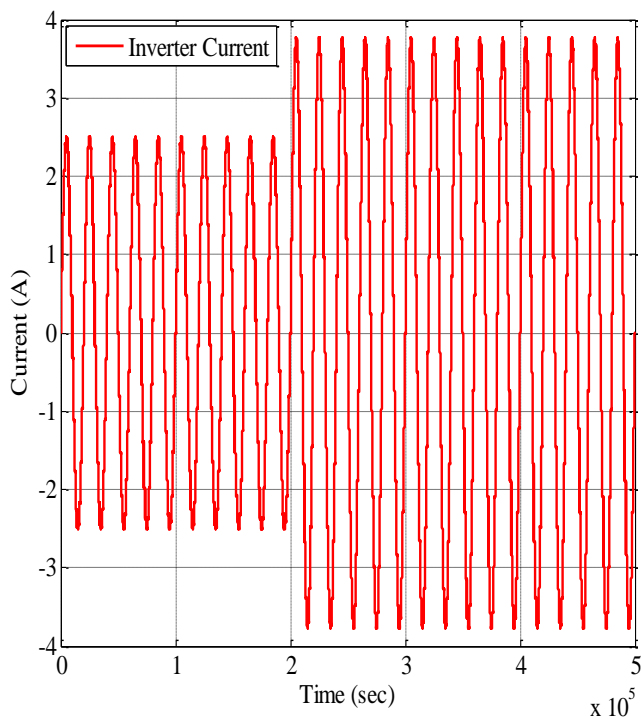

Fig. 6b Output current during load change

There is a little bit effect of oscillation which disturbs the output voltage and change the controller signal as well. When the proposed controller detects that, it regulates this disturbance by controlling the inverter modulation index through supply a suitable control signal. This is to say that the proposed controller algorithm has succeeded to track different load conditions in order to get the desired output voltage as compared to the reference value.

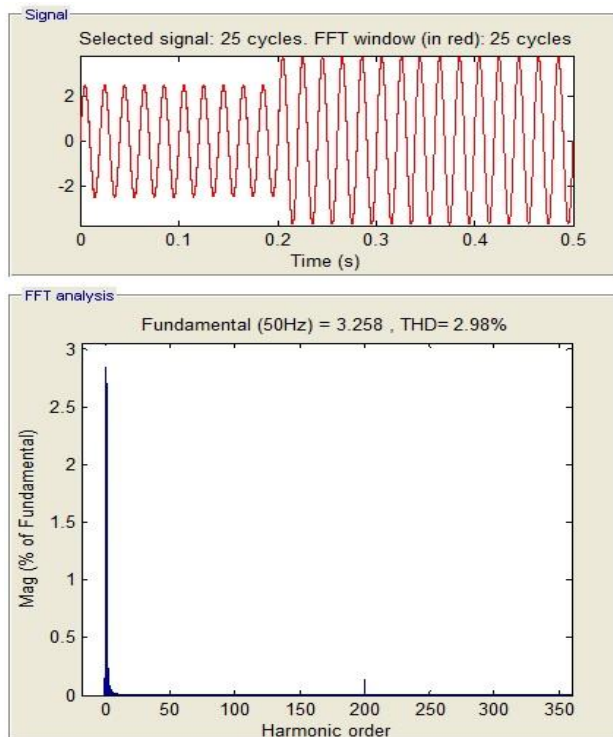

Fig. 7 THD for the output current

On the other hand and according to the standard IEEE-519-1992, the total harmonic distortion (THD) is one of the important standards that used to describe the quality signal of the inverter output waveforms. Therefore, Fast Fourier transform (FFT) has been conducted to the current and the voltage waveforms in order to calculate the total harmonic distortion for both of them which must be less than 5%. The THD for the output current waveform of the proposed inverter system is found to be 2.835 % shown in figure 7, which meets with the international standard along with 200th harmonic order (10 KHz) as a frequency spectrum. While, the THD for the output voltage waveform is 0.20 % as presented in figure 8 which conforms to the standards as well.

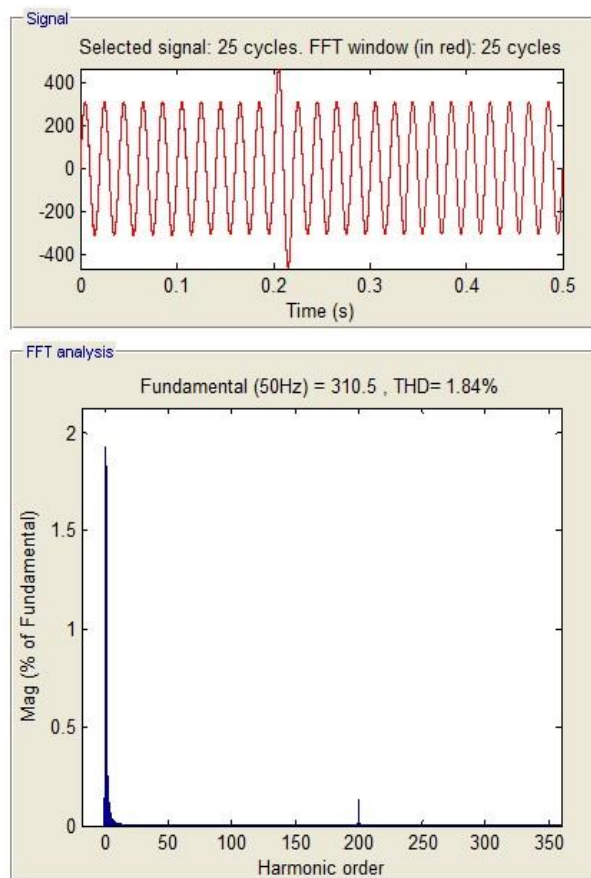

Fig. 8 THD for the output voltage

5. Conclusion

The In this research, an optimal voltage controller (MS-PI) has been proposed using MultiStart optimization algorithm for the standalone PV inverter under sudden load change. The main purpose of this algorithm is to find the optimal parameters of the PI controller automatically with inclusion of using the mean square error (MSE) as an objective function in order to improve the dynamic performance of the inverter output by minimizing the voltage error. The PV inverter and the developed control algorithm are modeled using MATLAB environment for both Simulink and Code (m.file). Based on the results, the developed control algorithm has clearly provided a very good transient

specifications in term of oscillation. Furthermore, it meets the international standard (IEEE-519-1992) in term of reducing the THD for both current and voltage outputs which are 2.98 % and 1.84 % respectively. Finally, an efficient evaluation between the developed algorithm and the PSO-PI algorithm has been done to ensure the accuracy in term of minimum error. It is found that the MSE value of the developed algorithm is 0.00049 as compared to 0.00599 of PSO-PI algorithm.

References

- [1] Younis M.A.A., Tamer Khatib, A Mohd Ariffin “An Improved Maximum Power Point Tracking Controller for PV Systems Using Artificial Neural Network”, *Journal of Electrical Review*, Vol. 88, No. NR 3b, pp. 116-121, 2012.
- [2] Muhamad M., R. Razali, H. Daniyal, Ali Mahmood “An Intelligent Voltage Controller for a PV Inverter System using Simulated Annealing Algorithm-based PI Tuning Approach”, *Journal of Engineering and Applied Sciences*, Vol. 12, No. 3, pp. 660-669, April 2017.
- [3] O. Ozgener, “A small wind turbine system (SWTS) application and its performance analysis”, *Energy Conversion and Management*, Vol.47, No. 11, pp. 1326-1337, July 2006.
- [4] T. Khatib, A. Mohamed, K. Sopian, “Optimization of a PV/wind micro-grid for rural housing electrification using a hybrid iterative/genetic algorithm: case study of Kuala Terengganu, Malaysia”, *Energy and Buildings*, Vol. 47, pp. 321–331, 2012.
- [5] Mushtaq Najeeb, Muhamad Mansor, Ramdan Razali, Hamdan Daniyal, Jabbar A. F. Yahaya, “Experimental Implementation Controlled SPWM Inverter based Harmony Search Algorithm”, *International Journal of Renewable Energy Research*, Vol.7, No.3, 2017.
- [6] A. M. Humada, M. Hojabri, M. B. Mohamed, Mushtaq Najeeb, M. H. Bin Sulaiman, “A New Method of PV Reconfiguration under Partial Shadow Conditions based on DC/DC Central Converter,” *International Journal of Renewable Energy Resources*, Vol. 4, pp. 49-53, 2014.
- [7] Sasmita Behera, Bidyadhar Subudhi, Bibhuti Bhusan Pati, “Design of PI Controller in Pitch Control of Wind Turbine: A Comparison of PSO and PS Algorithm”, *International Journal of Renewable Energy Research*, Vol.6, No.1, pp. 271-281, 2016.
- [8] B. Krishna Naick, T.K.Chatterjee, K.Chatterjee, Fuzzy Logic Controller based PV System Connected in Standalone and Grid Connected Mode of Operation with Variation of Load, *International Journal of Renewable Energy Research*, Vol.7, No.1, 2017.
- [9] M.N. Amrani, A. Dib, Predictive Direct Power Control of a Grid Connected Three-Phase Voltage Source Inverter for Photovoltaic Systems, *International Journal of Renewable Energy Research*, Vol.6, No.1, 2016.
- [10] F. Blaabjerg, Z. Chen, and S. B. Kjaer, “Power electronics as efficient interface in dispersed power generation systems,” *IEEE Transactions on Power Electronics*, Vol. 19, No. 5, pp. 1184–1194, 2004.
- [11] Humada M., M. H., Herwan Bin Sulaiman, and Hamada H., “Photovoltaic Grid-Connected Modeling and Characterization Based on Experimental Results”, *PLOS ONE*, Vol. 11, No. 4, pp. 1-13, 2016.
- [12] Ortega, R.; Figueres, E.; Garcerá, G.; Trujillo, C.L.; Velasco, D. “Control techniques for reduction of the total harmonic distortion in voltage applied to a single-phase inverter with nonlinear loads: Review”, *Renewable and Sustainable Energy Reviews*, Vol. 16, No. 3, pp. 1754–1761, 2012.
- [13] Mahmood H., Hojabri M., M. N., “ Reconfiguration Method Based on DC-DC Central Converter within Different Mismatch Conditions”, *International Journal of Engineering Science & Research Technology*, Vol. 2, No. 12, pp. 3634-3639, 2013.
- [14] R. Razali, H. Daniyal, M. Mansor, “An Efficient Control Implementation for Voltage Source Inverter based Harmony Search Algorithm”, *International Journal of Power Electronics and Drive Systems*, Vol. 8, No. 1, pp. 279-289, Mar. 2017.
- [15] IEEE STD 519-1992, “IEEE Recommended Practices and Requirements for Harmonics Control in Electrical Power Systems”, *Institute of Electrical and Electronics Engineers*, 1992.
- [16] G. Tsengenes, and G. Adamidis, “A multi-function grid connected PV system with three level NPC inverter and voltage oriented control,” *Solar Energy*, Vol. 85, No. 11, pp. 2595-2610, 2011.
- [17] Sanchis, P.; Ursaea, A.; Gubia, E.; Marroyo, L. “Boost DC-AC Inverter: A New Control Strategy”, *IEEE Transactions on Power Electronics*, Vol. 20, No. 2, pp. 343–353, 2005.
- [18] A. Muthuramalingam, S.V. Vedula, P.A. Janakiraman, “Performance evaluation of an FPGA controlled soft switched inverter”, *IEEE Transactions on Power Electronics*, Vol. 21, pp. 923–932, 2006.
- [19] M. Sreedevi, P.J. Paul, “Fuzzy PI controller based grid-connected PV system”, *International Journal of Soft Computing*, Vol. 6, pp. 11–15, 2011.
- [20] P. Sanchis, A. Ursæa, E. Gub’ia, and L. Marroyo, “Boost DC-AC inverter: a new control strategy,” *IEEE Transactions on Power Electronics*, Vol. 20, No. 2, pp. 343–353, 2005.

- [21] J. Selvaraj and N. A. Rahim, "Multilevel inverter for grid connected PV system employing digital PI controller," *IEEE Transactions on Industrial Electronics*, Vol. 56, No. 1, pp. 149–158, 2009.
- [22] Noradin Ghadimi, "PI Controller Design for Photovoltaic Systems in Islanding Mode Operation", *World Applied Sciences Journal*, Vol. 15, No. 3, pp. 326-330, 2011.
- [23] W. Li, Y. Man, and G. Li, "Optimal parameter design of input filters for general purpose inverter based on genetic algorithm," *Applied Mathematics and Computation*, Vol. 205, No. 2, pp. 697–705, 2008.
- [24] K. Sundareswaran, K. Jayant, and T. N. Shanavas, "Inverter harmonic elimination through a colony of continuously exploring ants," *IEEE Transactions on Industrial Electronics*, Vol. 54, No. 5, pp. 2558–2565, 2007.
- [25] Y. A.-R. Ibrahim Mohamed and E. F. El Saadany, "Hybrid variable-structure control with evolutionary optimum-tuning algorithm for fast grid-voltage regulation using inverter-based distributed generation," *IEEE Transactions on Power Electronics*, Vol. 23, No. 3, pp. 1334–1341, 2008.
- [26] Krishna B. Naick, T.K.Chatterjee, K.Chatterjee, "Fuzzy Logic Controller based PV System Connected in Standalone and Grid Connected Mode of Operation with Variation of Load", *International Journal of Renewable Energy Research*, Vol.7, No.1, pp. 311-322, 2017.
- [27] Mohammad Monfared, Saeed Golestan, and Josep M. Guerrero, "Analysis, Design, and Experimental Verification of a Synchronous Reference Frame Voltage Control for Single-Phase Inverters", *IEEE Transactions on Industrial Electronics*, Vol. 61, No. 1, 2014.
- [28] M. N., M. Hojabri, H. D., Mahmood A., "Simulation of Regulated Power Supply for Solar Photo-Voltaic Model", *International Journal of Engineering Science & Research Technology*, Vol. 2, No. 12, pp. 3607-3613, Dec. 2013.
- [29] M. N., Muhamad Mansor, Hameed Feyad, Esam Taha, Ghassan Abdullah, "An Optimal LFC in Two-Area Power Systems Using a Meta-heuristic Optimization Algorithm", *International Journal of Electrical and Computer Engineering (IJECE)*, Vol. 7, No. 6, pp. 3217-3225, December 2017.
- [30] M. Najeeb, M. Humada Mojgan H., A., H. D., Hatem Fahad Frayyeh, "An Overview on Microgrid Control Strategies" *International Journal of Engineering and Advanced Technology*, Vol. 4 No. 5, pp. 93-98, June 2015.
- [31] Mushtaq N., Ramdan bin Razali, K. G. Mohammed, Hamdan bin Daniyal, Ali M. Humada, "PID Parameters Improvement for AGC in Three Parallel-Connected Power Systems", *the National Conference for Postgraduate Research*, Universiti Malaysia Pahang, NCON-PGR-P075, pp. 544-551, 2016.
- [32] Kaisa Miettinen. *Nonlinear Multiobjective Optimization*. Springer, 2012; ISBN 978-0-7923-8278-2.
- [33] Ching-Lai Hwang; Abu Syed Md Masud. "Multiple objective decision making, methods and applications: a state-of-the-art survey", Springer-Verlag, 2012; ISBN 978-0-387-09111-2.
- [34] Rinnooy A. H. G. Kan and G. T. Timmer "Stochastic global optimization methods part II: Multi level methods", *Mathematical Programming*, Vol. 39, No. 1, pp. 57–78, 1987.
- [35] Ammar Hussein Mutlag, Azah Mohamed, and Hussain Shareef, "A Nature-Inspired Optimization-Based Optimum Fuzzy Logic Photovoltaic Inverter Controller Utilizing an eZdsp F28335 Board", *Energies*, Vol. 9, No. 120, pp. 1-32, 2016.